











1	SW80317		1x	2700x2700x2200	30kg
2	SW80336		1x	139.7x133.7x2350	25kg
3	SW87683		1x	140.3x157	3.2kg
4	SW86318		4x	20mm; 454-672mm	2.3kg
5	SW80319		1x	280x280x154	8kg
6	SW80335		1x	4792x150x150 (100x50x3)	35kg
7	SW80345		2x	2370x50x150 (100x50x3)	17kg
8	SW80322		1x	280x280x160 (114OD)	8.5kg
9	SW80326		4x	496x370x2	3kg
10	SW80327		8x	500x370x47	3.6kg
11	SW80324		4x	500x370x2	3kg
12	SW80325		4x	500x500x2	10kg

13	8050050		64x	Washer ISO7089-10.5x20x2	0.004kg
14	8035699		8x	Washer ISO7089-13x24x2.5	0.006kg
15	8050052		8x	Washer ISO7089-17x30x3	0.011kg
16	8057703		2x	Screw, ISO4014-M16x120-8.8	0.2280kg
17	8008788		6x	Nut, Fujilok-M16-8-RingA2	0.036kg
18	8008518		16x	Screw, ISO10642-M10x30-10.9	0.023kg
19	8008796		32x	Nut, Fujilok-M10-8-RingA2	0.011kg
20	8008371		32x	Screw, ISO4017-M10x25-8.8	0.0263kg
21	8008797		8x	Nut, Fujilok-M12-8-RingA2	0.017kg

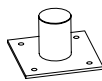

S6

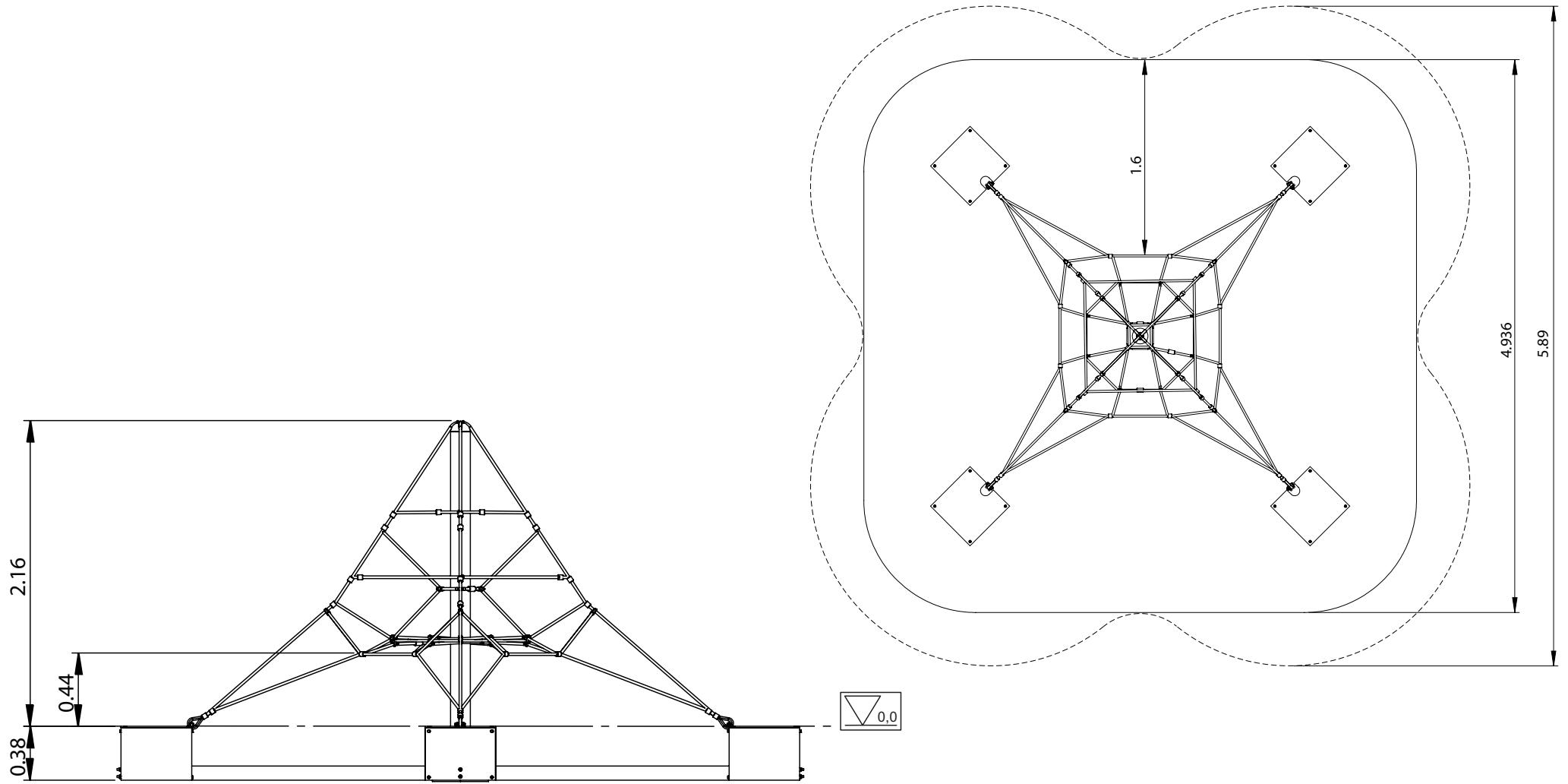
EN1176

0.44m

S13

m³

1.072

S15

L x W x H (m)

2.7x2.7x2.2

S12

kg

265

S20

2 x 12

S18

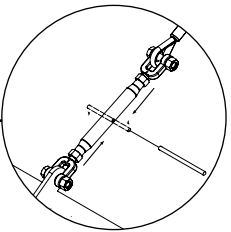

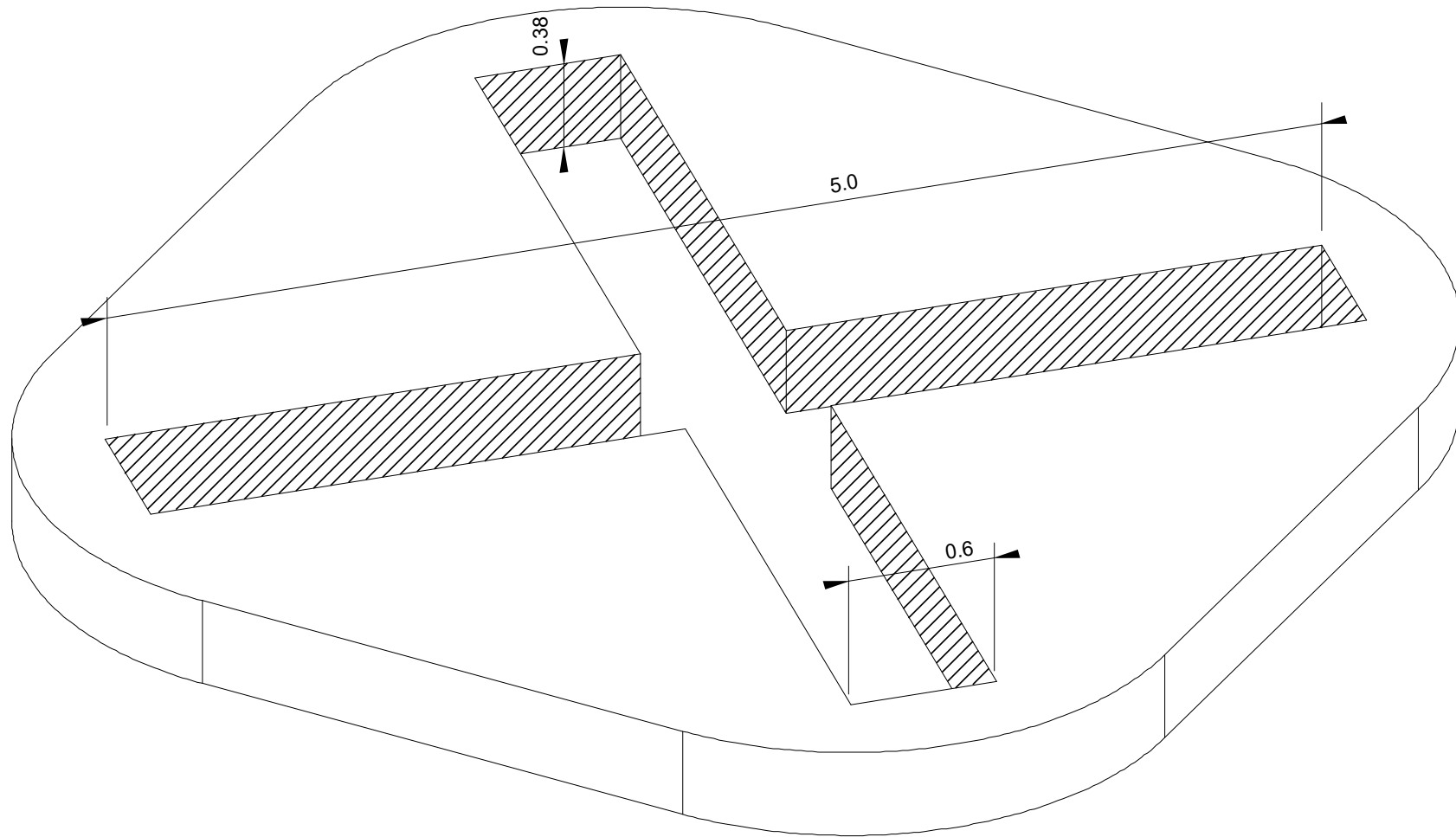

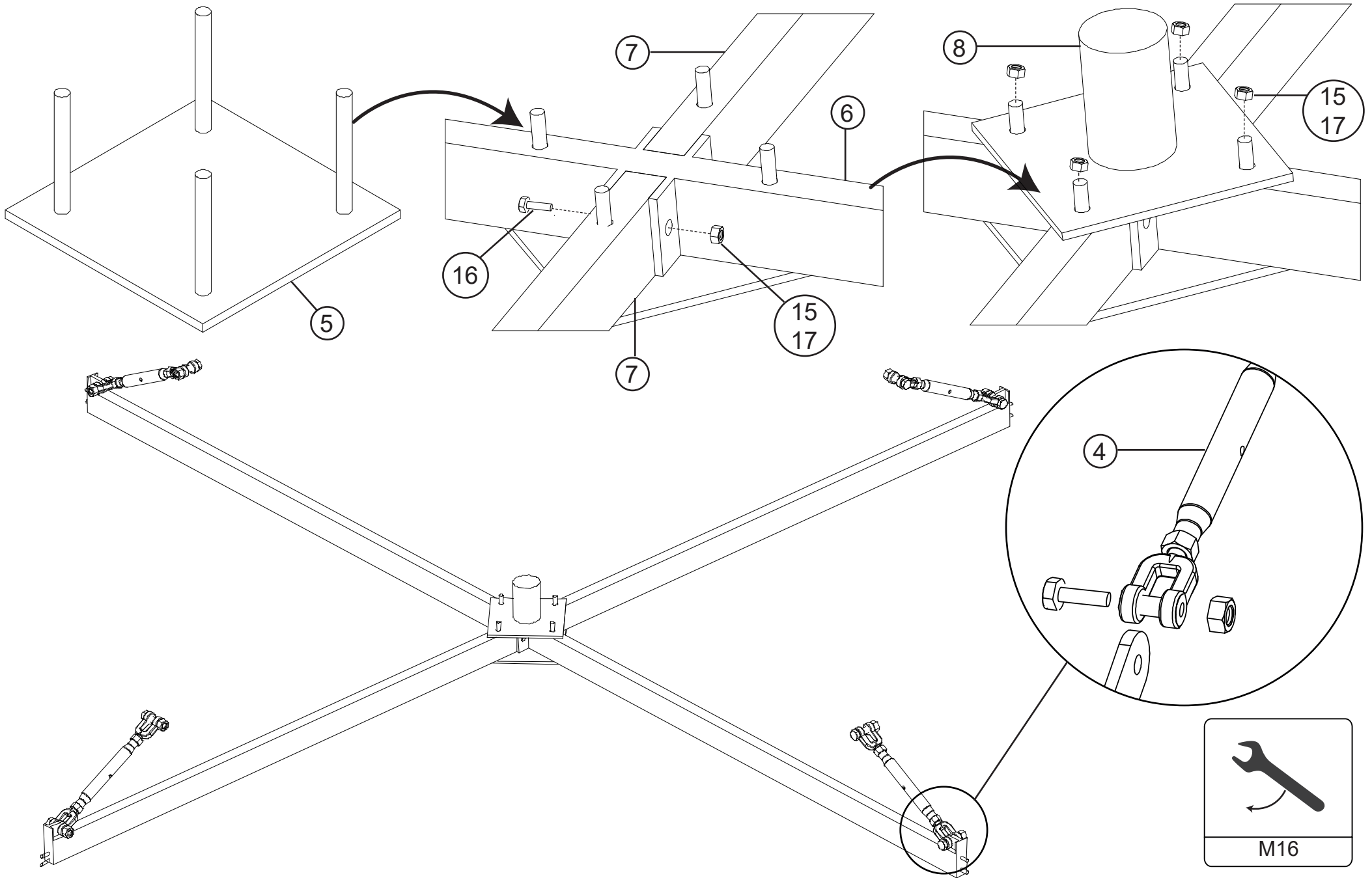

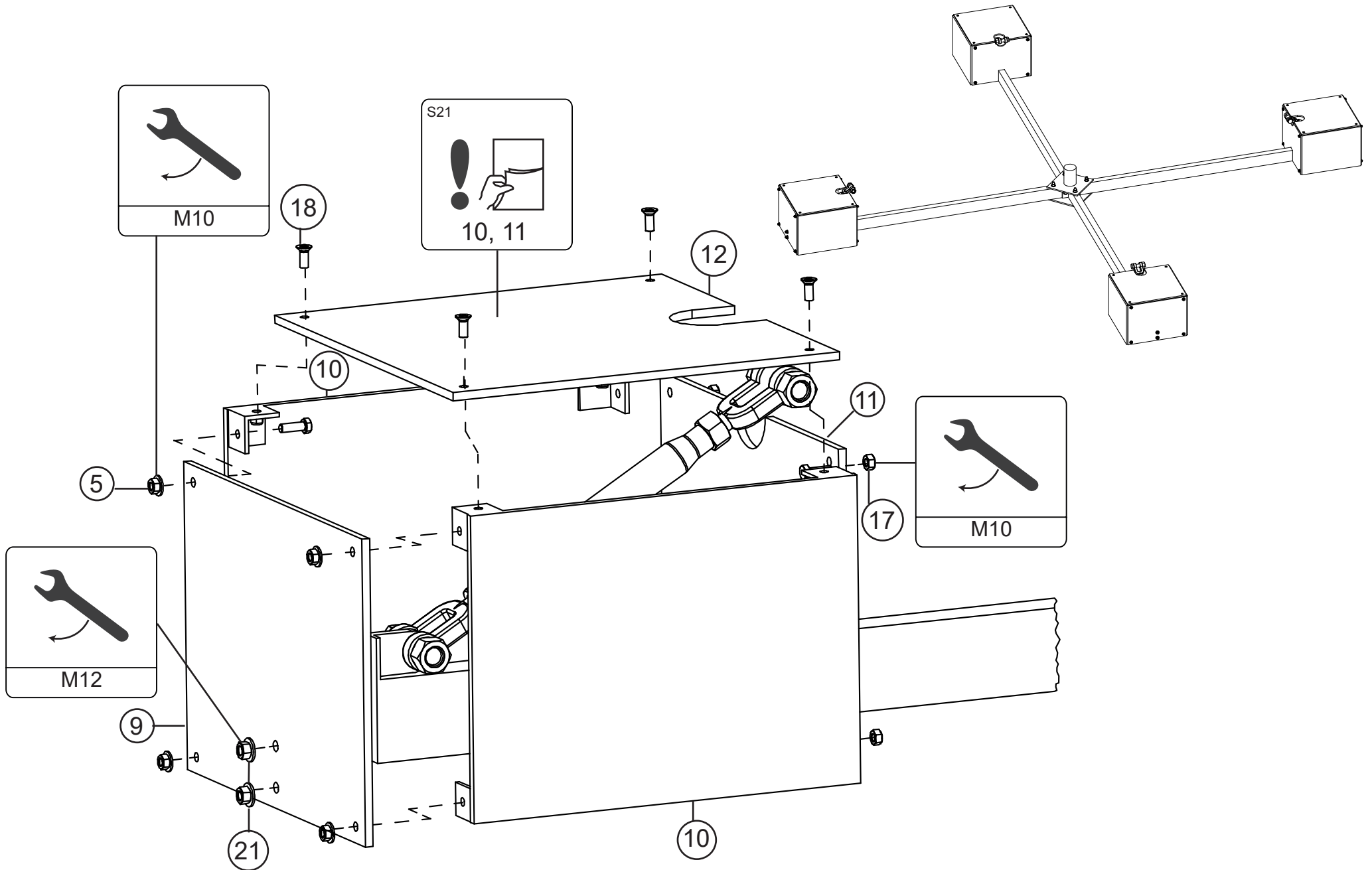

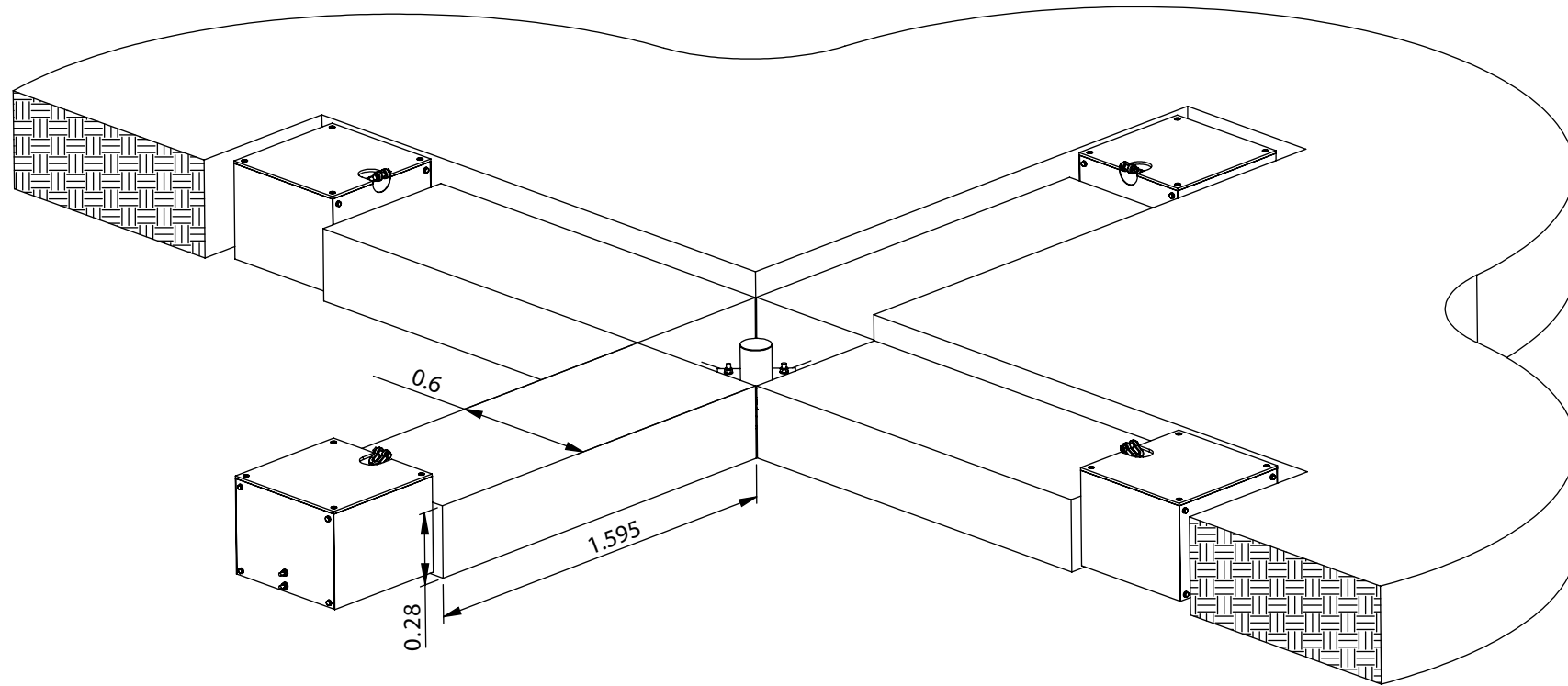
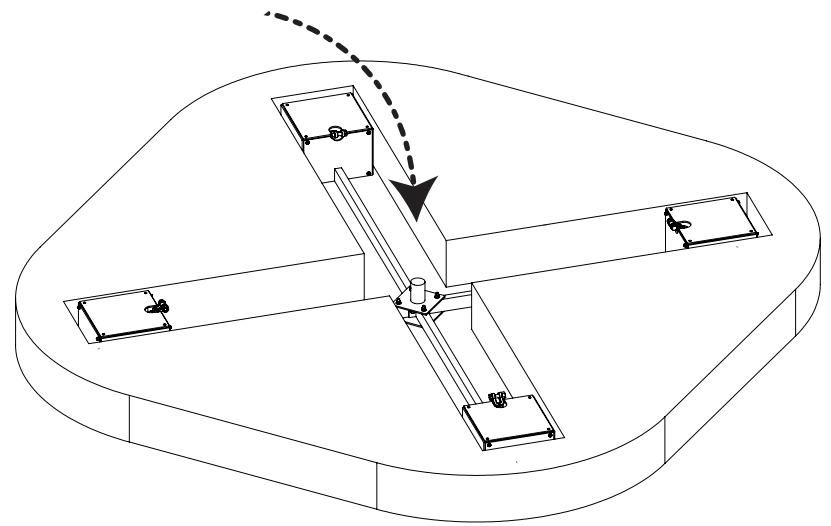



S25	
1.072m ³	30Nmm ³
	24x7
	101

